

PRODUCT DATA SHEET

ODIN

Pouf System

DESIGN

Ozan Sinan Tiğlioğlu



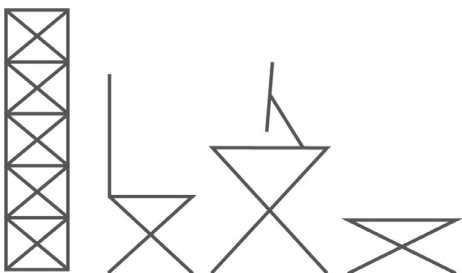

Odin provides different compositions to comply with the interior design. Technically, the structure of the legs can be adapted to many areas with its form. It forms alternatives with its flexible structure. Legs are solid wood and supported by steel. Accessories such as magazine holders and electrical connections provide different options to the user.



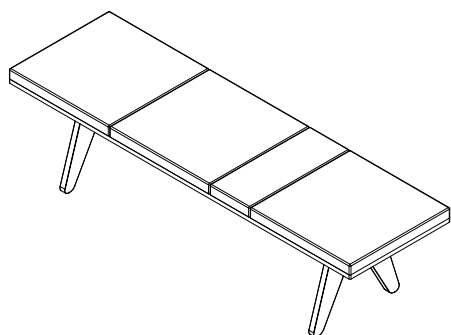

tunaofis

VARIATIONS



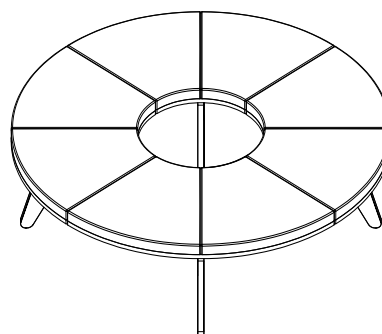

Standard Base		
Product Code	L/W/H (cm)	Material
8251 01050170 01	170x50x45,5	Fab.+Plyw./KT1
8251 01050170 02	170x50x45,5	Fab.+Plyw./KT2
8251 01050170 03	170x50x45,5	Fab.+Plyw./KT3
Gross Weight		
	19 kg	
Packaging		
	180x60x30 cm (0,324 m ³) 22 kg	

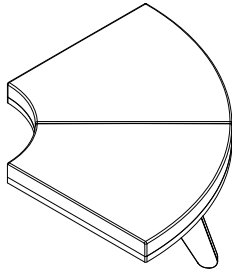

Standard Base		
Product Code	L/W/H (cm)	Material
8251 02150150 01	150x150x45,5	Fab.+Plyw./KT1
8251 02150150 02	150x150x45,5	Fab.+Plyw./KT2
8251 02150150 03	150x150x45,5	Fab.+Plyw./KT3
Gross Weight		
	39,2 kg	
Packaging		
	160x160x30 cm (0,768 m ³) 42 kg	

ACCESSORIES



Standard Corner Base		
Product Code	L/W/H (cm)	Material
8251 03075075 01	75x75x45,5	Fab.+Plyw./KT1
8251 03075075 02	75x75x45,5	Fab.+Plyw./KT2
8251 03075075 03	75x75x45,5	Fab.+Plyw./KT3
Gross Weight		
	9,8 kg	
Packaging		
	80x80x30 cm (0,192 m³) 11 kg	

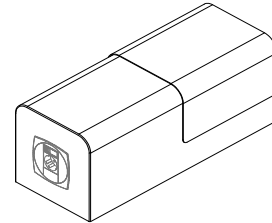

Plug Holder		
Product Code	L/W/H (cm)	Material
8251 04020050 01	20x50x20	Fabric + Metal KT1
8251 04020050 02	20x50x20	Fabric + Metal KT2
8251 04020050 03	20x50x20	Fabric + Metal KT3
Gross Weight		Packaging
7 kg		60x22x30 cm (0,05 m³)

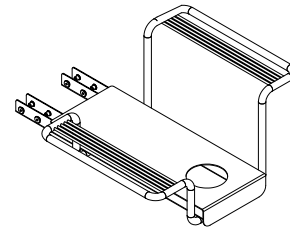

Magazine Holder		
Product Code	L/W/H (cm)	Material
8251 05058022 01	58x22x25,6	Metal Painting
Gross Weight		Packaging
6 kg		60x22x30 cm (0,05 m³)



Coat Hanger		
Product Code	L/W/H (cm)	Material
8251 05005005 01	5x5x105,2	Solid Wood Natural
Weight		Packaging
1 kg		100x10x20 cm (0,011 m³)

INFORMATION

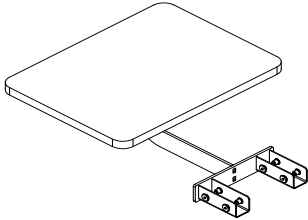

Coffee Table		
Product Code	L/W/H (cm)	Material
8251 05030040 01	30x40x20	Solid Wood + Metal
Weight		Packaging
3 kg		50x50x30 (0,075 m ³)

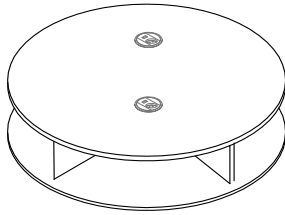

Coffee Table & Plug Holder		
Product Code	L/W/H (cm)	Material
8251 05048048 01	48x48x20	Solid Wood
Weight		Packaging
3,2 kg		50x50x30 (0,075 m ³)

Combinations

You can combine with coffee tables.
Please, see Product Data Sheets for Coffee Tables.

Fabrics

You can use fabrics from
Category 1, Category 2 and Category 3.

Category 1: Lucia.

Category 2: Urban Plus, Gravity.

Category 3: Synergy, Nexus.

Please, see Product Data Sheets for Fabrics.

Legs

Legs are from Plywood.

Please, see Product Data Sheets for Materials.